

## Assembly Manual

### PACKING LIST:

x02 Type **W**<sub>20</sub>

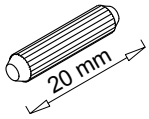

Wooden dowels

x1 Type **M6x20**

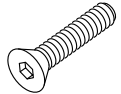

m6x20 mm

x1 Type **H**

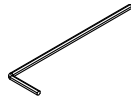

Hex wrench

### INSTRUCTION FOR USE AND CLEANING :

- clean with a soft cloth, slightly humid or specific products for wood or lacquer;
- avoid the use of abrasive cleaners.

### TOOLS:

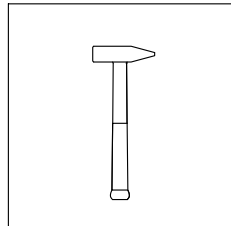
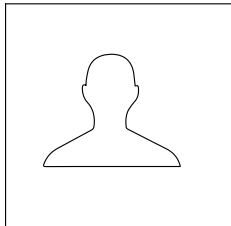
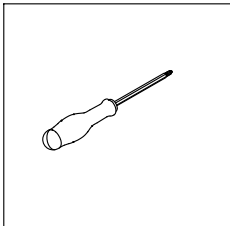

# Zaor<sup>®</sup>

UPGRADE YOUR SPACE

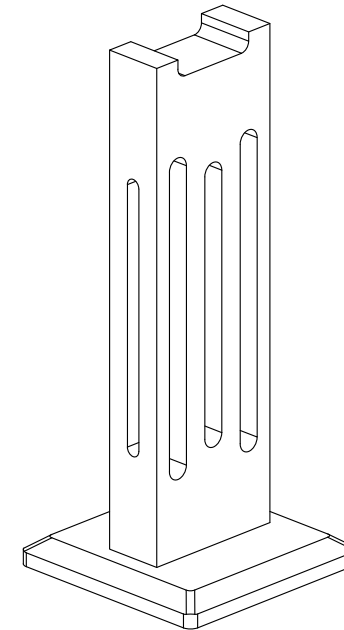

## Headphone Stand

### Assembly Manual

## Assembly Manual

Unpack the parts carefully and set up so that you can see the part numbers clearly. In the big box you should find a small cardboard box with all the screws and bolts for assembly.

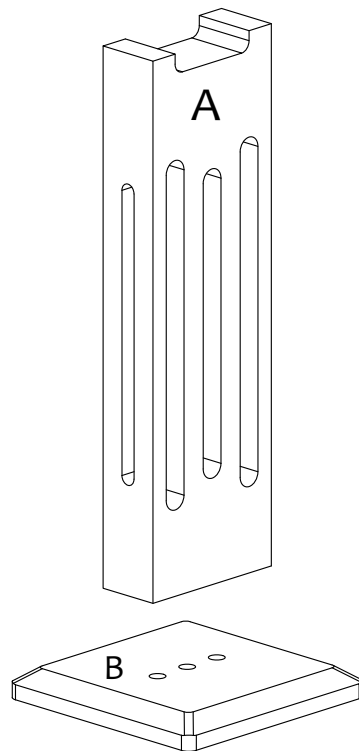

Here you have an exploded view of the whole stand and how it is supposed to come together. We use high quality furniture assembly components from renowned EU manufacturers. Please, never use force. These parts should come together easily, in case of doubt check the manual again or contact support.

## Assembly Manual

### STEP 1

Push wooden dowels Type W in the appropriate holes

